

# ABHIVARG

Volume 6 issue 1



DEPARTMENT OF  
ELECTRONICS AND TELECOMMUNICATION





# **ABHIVARG 6.1**

**Engineering Education  
& Practices for a  
Healthy Mankind**

# DEAN'S MESSAGE



## Dr. Lochan Jolly

**Dear Students,**

**It always gives me immense pleasure to speak to you all through this platform.**

**Happy Diwali to all of you. Hope all of you had a great Diwali.**

**Now that SE students have started coming to college for practicals, it is really good to see the students back in campus after so long. We teachers have really missed you all for so long.**

**Hope soon every thing will be normal and we all will function the way we used to work pre-covid.**

**I would request all to take care and be cautious. Do not forget the protocols for your safety.**

**God Bless you all**

# HOD'S MESSAGE



**Dr. Payel Saha**

**It is an honor and pleasure to write this message to all readers. I am glad to pen for “Abhivarg” as an appreciation of the commendable efforts put forth by the editorial team. This is a productive technical material and subsidiary skill-developing tool for the students. The efforts taken to bring about innovative content are appreciable. I also applaud the coordination and efforts behind the team to bring out this issue. The most important aspect we could derive from this stupendous effort is that it brings out the various technical and analytical skills of budding engineers. Real success requires step after step after step after step. It requires choice after choice; it demands education and passion and commitment and persistence and hunger and patience. I wish that “Abhivarg” establishes to be a flint to fire the enthusiasm and excite the minds for many intrusive innovations among the students and inspire passion among the members of the faculty of Electronics and Telecommunication Engineering department. My greeting to the editorial board to keep the good work. I wish you all triumph and a grand operation throughout the year.**

# FACULTY INCHARGE'S MESSAGE



## **Mrs. Megha Gupta**

**Hello,**

**Welcome to all of you for the new edition of Abhivarg. It's the time when everyone is talking about COVID-19. We are living in an era when time has taken a new leap. A leap towards a different world. Living has changed. Work culture has changed. Lifestyle has changed. Dictionary has got some new words, but kids have understood their meanings without searching the dictionary. We all are familiar with "The New Normal". Stay home, stay safe are the new words of best wishes. This pandemic has feared everyone for the lives of their near and dear ones.**

**This difficult time has taught us to be self-reliant. Our nation is getting newer and has difficult situations to fight with. Pandemic, border issues and internal affairs, and many more. "Aatmanirbhar" is what our prime minister wants us to be as an individual and as a nation too. We can see a wave in Indians to boycott Chinese products. But with this comes the responsibility and duty of every Indian to contribute to this noble cause of serving the coming generation in some or another way. As an engineer, our responsibility is towards research and development. Innovative ideas and designs can help entrepreneurs to convert them into products, wherein we need not pay any import duty while buying such products. Budding engineers mostly think of foreign universities. But after getting degrees they never feel like coming back and serving their own nation. This brain drain should be choked now. With this, I would like to wish you all a healthy and safe year ahead.**

# TABLE OF CONTENTS

## **I. INTRODUCTION**

<i>Dean's Message</i>	<b>03</b>
<i>HOD's Message</i>	<b>04</b>
<i>Faculty Incharge's Message</i>	<b>05</b>

## **II. STUDENTS**

<i>TELEMEDICINE</i>	<b>09</b>
<i>Engineering Giving a Boost To HealthCare</i>	<b>11</b>
<i>How IEEE Roboticists Use 3D Printers to Make PPE for Healthcare Workers</i>	<b>14</b>
<i>Website For Infographics Of New Education System</i>	<b>17</b>
<i>Smart Water Management System</i>	<b>20</b>
<i>Solagro</i>	<b>22</b>
<i>Bon Happétee: Measure calories from your food image</i>	<b>25</b>

# TABLE OF CONTENTS

## **III. INDUSTRY**

*The Impact of Sudden Shift from Offline to Online during COVID-19* **29**

*Impact of COVID-19 on Small Businesses* **32**

## **IV. ALUMNI**

*Painting outside the Boundaries* **36**

## **V. FACULTY**

*Optical Elements & its properties* **41**

*Role of Engineers in today's modern world* **43**

## **VI. TEAM**

*Credits* **46**

*Acknowledgment* **48**



**STUDENTS**



# TELEMEDICINE



## ANANYA SRIVASTAVA

TE E&TC B

The use of the facts era to present fitness care from one place to every another is referred to as telemedicine. This system constitutes the usage of the telecommunications era to offer clinical facts and offerings. Telemedicine refers to the usage of the phone for clinical functions in addition to remote education, however, it's miles an increasing number of getting used as a shorthand for faraway digital medical care. Despite the truth that telemedicine has simplest been employed sparingly in Indian fitness care to yet, the 2020 Covid-19 epidemic gives the country's fitness offerings an extraordinary hazard to get admission to and insurance everywhere in the country. The wireless broadband era has stepped forward over the past numerous decades, and molecular telephone and the net at the moment are

getting used everywhere. People, no matter their stage of education, are capable of examining this mode of verbal exchange and observing it in their day-by-day life



**Fig 1. Telemedicine: the remote delivery of healthcare services**

## NETWORKED PROGRAMS

In technical terminology, networked programs involve programs that facilitate the connection between one network service to another or from one network to multiple network services. This process involves the management and delivery of digital resources to computer networks. This concept finds use in the field of telemedicine. Remote health clinics are linked to bigger health facilities such as

urban hospitals via networked connections (such as high-speed internet lines). The ISRO Pilot project is considered one of the first implementations of networked programs in India.

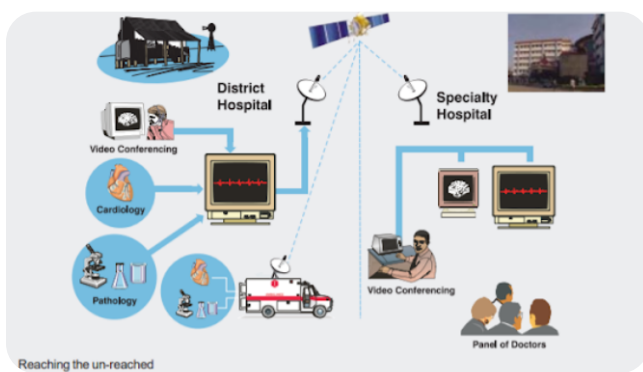
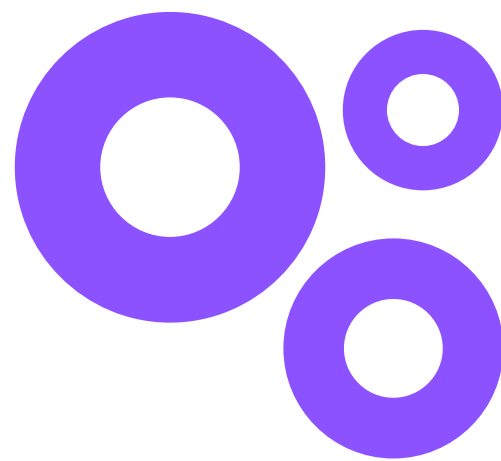

Fig 2. Networked Programs

### POINT TO POINT CONNECTIONS

In the field of telecommunication, a point-to-point connection is a communications link between two communication endpoints or nodes. In this case, small rural health facilities are connected to one major central health facility via high-speed internet via point-to-point links. Smaller or understaffed clinics can outsource medical care to specialists in other locations within the same health system using this form of telemedicine connection. Telepsychiatry, teleradiology, urgent care services frequently use point-to-point connections. This point of communication guarantees contact between two specialists who can then confer with each other regarding testing and diagnosing.



### MONITORING CENTRE LINKS

This form of connection is between the hospital or medical institute and the patient, hence giving the concept of remote patient monitoring. This form of telemedicine link establishes a digital link between a patient's home and a remote monitoring center, allowing medical data to be measured at home and electronically relayed to a remote medical monitoring facility. This creates a system in which patients can interact with doctors and health care providers over large distances within the safety of their homes. Several companies such as Vidmed, Practo, DocOnline are spearheading this form of telemedicine.

Telemedicine is proving to be a fundamental and viable alternative to the existing systems. The ability to connect to health care facilities all over the globe will be a suitable method to establish communication and work towards diagnosis, treatment, and prevention of diseases that are originating in different parts of the country.

# ENGINEERING GIVING A BOOST TO HEALTHCARE

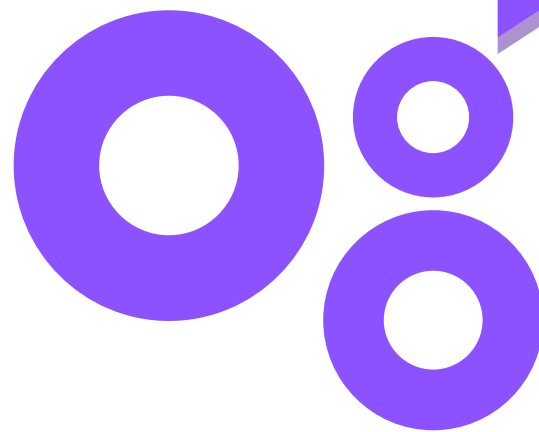

Engineering sciences have a great impact on society as a whole. It has completely changed our society, from modern homes to bridges, space travel, automobiles and the latest mobile technologies. An engineer's work is driven by innovative ideas and uses his skills to create new and exciting opportunities and to address difficulties that arise. Engineering sciences are widely used in modern medicine and healthcare to improve the prevention, diagnosis, and treatment of disease. These technologies are critical to healthcare, but these contributions are often overlooked.

For the cause of diagnosing, tracking, and treating clinical diseases, imaging gadgets use visual, ultrasonic, or electromagnetic era to look at the human body. Imaging lets clinicians attain non-invasive data in approximately regular and strange states.



**TANISHI TEWARI**

TE E&TC B

## CONTRIBUTIONS

### MEDICAL IMAGING

It became previously restrained to supplying data approximately anatomy, maximum significantly fractured bones. Anatomical imaging strategies along with ultrasound, x-rays (in particular x-ray CT, which makes use of imaging of "slices" to create 3-D pics), and magnetic resonance

imaging (MRI) keeps supplying gradually high-resolution pics of organs. Functional imaging has grown to be a key development in clinical imaging in latest years. Contrast-enhanced MRI, Doppler, and contrast-enhanced ultrasound are examples of this. Engineers have devised strategies to examine such photos, align them, and mix pics of various sorts in equal time to maintain up with the progress.

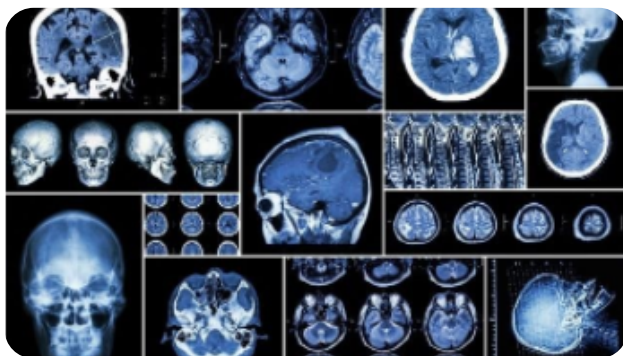

**Fig 1. Medical Imaging**

## **SURGERY**

Almost every aspect of surgery, from the design of the operating room to the instruments used there, is dependent on engineering. Engineering has found applications in surgery in the following cases.

- **Keyhole surgery**

Keyhole surgery, also known as minimally invasive surgery, is a type of surgery that allows doctors to access the interior of the body through a small incision rather than an open incision, eliminating the need for open surgery. Engineers have created miniature cameras and lighting systems to be inserted into the body for this technology

- **Endoscopy**

An endoscopy is a way wherein an endoscope is used to have a look at the organs inner a frame. A long, thin, bendy tube with a mild and digital digicam at one give up is referred to as an endoscope. On a tv screen, pics of the inner of your frame are displayed. Endoscopes and different contraptions permit surgeons to function on sufferers via very small incisions, taking into consideration substantially quicker restoration and recuperation than conventional surgery.

- **Medical Robots**

Medical robots are already in use in orthopedic surgery, cardiac surgery, and other fields of surgery, ensuring that fewer mistakes are made and that physicians may meticulously plan surgical operations knowing that the robot will operate consistently.

## **SIMULATION AND TRAINING**

Any instructional hobby that makes use of simulation aides to mimic medical instances is known as simulation-primarily based totally clinical education. Although clinical simulation is new, simulation has been applied in different

professions for a protracted time. Simulation in clinical and surgical personnel education has the capacity to deal with the various problems supplied via way of means of restricted resources, fewer hours, and accelerated process complexity. Engineers collaborate with surgeons and different clinical specialists to create processes and structures which are as close to real-international centers and strategies as possible.

## CARDIAC IMPLANTS

The invention of the silicon transistor in 1958 enabled electrical engineers to create the first pacemaker to be implanted in humans. A pacemaker is one of a growing number of medical devices that are placed into the chest via minimally invasive surgery to help control and aid the heart's beating. It uses low-power electrical pulses to help manage an aberrant or fast heart rhythm or to speed up a slow heartbeat. Pacemakers can be externally programmed, allowing the best pacing mode for each patient to be selected. A pacemaker and a defibrillator are sometimes integrated into a single implanted device.

## ARTIFICIAL JOINTS

An artificial joint is plastic, ceramic, or metal prosthesis or prosthetic joint that is implanted to replace a damaged or diseased natural joint. Every year, one million artificial hips and knees are implanted in patients all around the world.



**Fig 2. Artificial Joints**

Engineers design, develop and manufacture these joints, and ongoing research is conducted to improve processes, materials, and the spectrum of prostheses available. Engineering has also enabled the creation of rehabilitation equipment that will aid patients following surgery, as well as the numerous devices.

## REGENERATIVE MEDICINE

Disease, trauma, congenital disorders can harm tissues or organs, hence regenerative medicine aims to replace them. Engineers and biologists are collaborating to create and commercialize technologies that will allow health practitioners to use a larger range of regenerative treatments. For eg., Somatic cell implants could lead to the production of tissue materials that improve a patient's ability to heal on their own. To get the technology back to the patient, many engineering disciplines are required.

# How IEEE Roboticists Use 3D Printers to Make PPE for Healthcare Workers

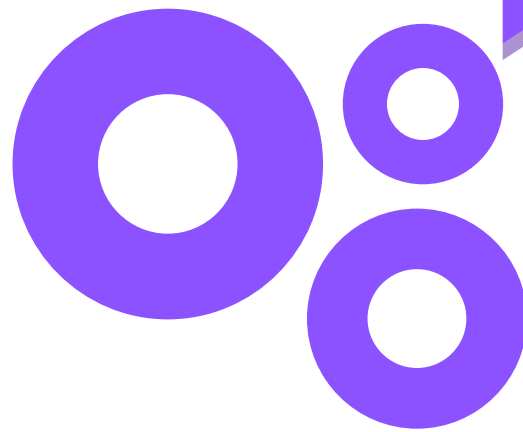

**ROSHNI KINI**

TE E&TC A

Before digging deep into how the 3D printers help make PPE for healthcare workers, let's have a look at what exactly engineering is and how has it been evolved over the years for the betterment of humankind. The application of science and math to solve problems is known as engineering. Engineers figure out how things operate and put scientific discoveries to use. Engineers are crucial in making innovations available to the rest of the world. Scientists and inventors are typically given credit for breakthroughs that improve the human condition, but engineers are crucial in making those ideas

available to the rest of the world. Engineering is significantly used in modern medicine and healthcare to improve disease prevention, diagnosis, and treatment. These technologies are critical to the National Health Service's efficient delivery of health care (NHS). However, engineering's contribution to health care is sometimes overlooked. Let's look at the key contributions of engineering for a better and healthy humankind are Medical imaging, Simulation, and training, Cardiac implants, Neural engineering, Surgery, Artificial joints, Mobile health, Healthcare IT, Regenerative medicine, etc

3D printers work like inkjet printers. Instead of ink, 3D printers deposit the desired material in successive layers to create a physical object from a digital file.

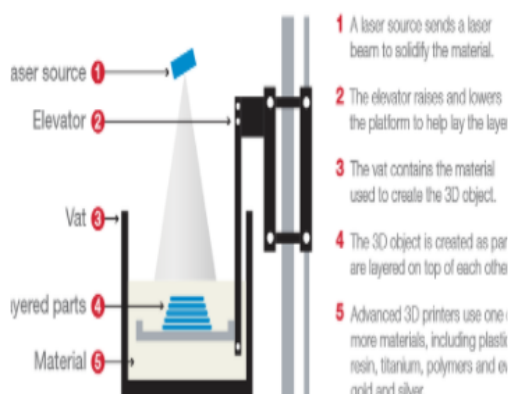

**Fig 1. Demonstration of how a 3D printer works**

## THE BODY

Engineering aspects are often not shown in the limelight but are as important as medical aspects in health-related issues. All those hefty machines and equipment used during evaluation, surgery, testing, etc would not have been possible without having involved engineering in the medical field. With passing years, and the advances in each and every field, this has given rise to a lot of new challenges. There are technical, educational, health, waste management, traffic-related, pollution, population, etc problems that are being created with no solutions. Similarly, in the year 2020, came the deadly virus, the coronavirus disease. There were lockdowns, quarantine situations, isolation, etc owing to this virus. Very few people on the streets were seen with masks, maintaining a fair distance from each other, sanitizing their hands, etc. Overall, it was a horrible situation all over the world. There was tension among the political leaders who lead the country on how to come out of this situation. The doctors had been vital in playing their roles in treating the people affected with corona, risking their lives. There were researchers who played an important role by keeping their research going on to find solutions for the vaccines. And then there were engineers, who were trying to figure out new ways to overcome this situation in an efficient manner. One such brilliant thing is the making of PPE using 3D printers.

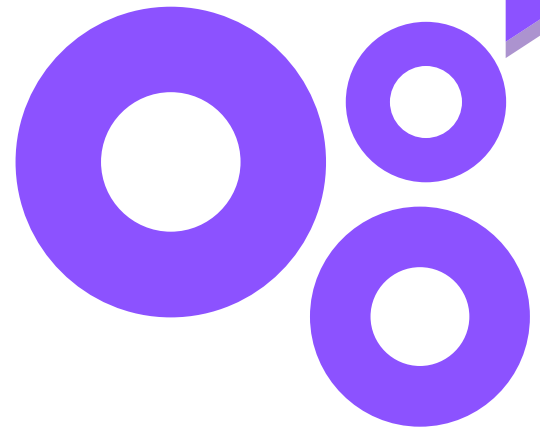

## PERFORMANCE EXPERIMENT

The team that made this possible includes IEEE members Ildar Farkhatdinov, Joshua Brown, and Kaspar Althoefer. 3D printers, stereolithography, and fused deposition modeling are the main technologies. Stereolithography uses a liquid resin in a 3D printer to create an item, whereas fused deposition modeling uses thermoplastic filaments. The system makes use of low-cost standard 3D printers that are simple to set up and use at home. The pace of production, on the other hand, is slow. The current production rate is 100 visors each day, but they have built a visor prototype using injection molding, which involves pouring molten material into a mold to create pieces. This will boost daily manufacturing to up to 50,000 units. There were quite a few challenges faced as well, but the results were great and the feedback was mostly positive. Because of the travel limitations in London and the rest of the United Kingdom, it was difficult to schedule regular deliveries of the manufactured visors. It was also challenging to obtain enough components, such as printing filament and acetone sheets for the visors. There aren't enough

for all of us because other COVID-19 manufacturing ventures are also ordering supplies. Plans are to scale production for up to 50,000 face visors per day.

On a concluding note, Despite the chaos, the increased use of digital technologies for professional communications and artificial intelligence to track COVID-19 patients' rehabilitation yielded some promising results. Many broad themes will become crucial as society advances to address challenges like COVID-19. Larger steps will be needed to ensure careful handling of biowaste, a stronger focus on indigenous capability-based manufacturing will be required, and issues like antimicrobial resistance will require more attention. The goal is that post-pandemic civilization would pay more attention to nature's warning signs and try to make manufacturing systems more resilient to coming threats.

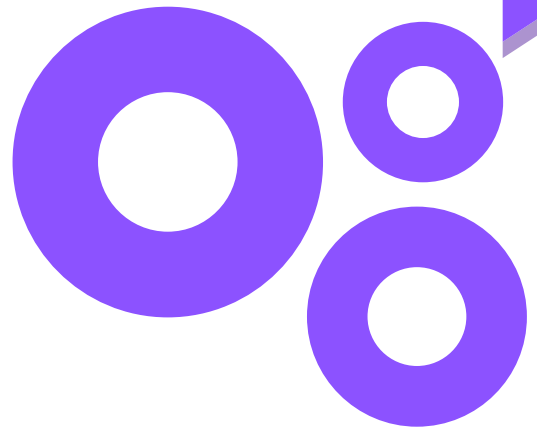



# Website For Infographics Of New Education System

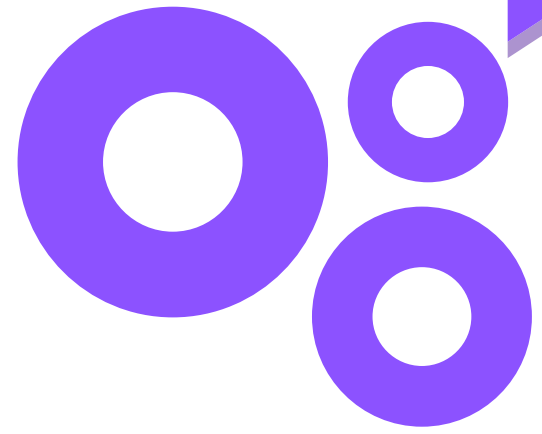

**SHWETA CHAVAN**

TE E&TC A

The draft of the new education policy of India was released first in the year 1986, by the government led by Mr. Rajiv Gandhi. The second-most renewal of the Education Policy was done in the year 2020, the current year, by the government led by Mr. Narendra Modi. The new education policy is highly appreciated by every citizen of India, because of the changes brought in this one. But the implementation of the system would be done in a couple of years. As of now, there are many websites that are providing trivial information about the policy, but not even a single which provides complete information in a very user-friendly way. The government itself has released a document online which is in the .pdf format, which, of course, is not feasible to the general public due to the vast readings. The other websites, while the literature survey, were found out to be providing information on a single topic, without complete information in a nutshell. Hence, our group came up with the idea of providing a website to the locals, which would not only give complete information about the New Education Policy but also

have some creatives to attract the audience.

The project is completely aiming to provide the entire piece of information about the New Education Policy proposed by the Government of India, via a website, that is accessible to the general public in just a click. The importance of the project is that it would be explaining in short, yet everything about the NEP 2020. The resource materials, which are generally hard to be found on the internet for free, would be provided in our website for free in PDF form. These resource materials would again be divided into categories to make it quite representable. Hence, the

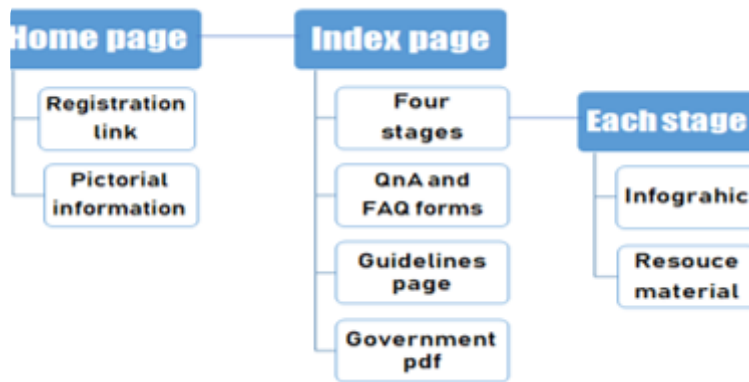

**Fig. 1 – Design Flow**

students, parents, teachers, and the public, in general, would be highly benefited by the project.

## PROPOSED DESIGN

### A. Content-Based Filtering

We tried connecting the public with the virtual world for the new education policy. We planned for making a user-friendly website, where the general public won't find it difficult to access the data easily. The website has a home page. This home page has a link to the best available site which has the relevant news about the current topics. The homepage also has a link to the marquee texted new events, which leads to google forms for people to register themselves for the upcoming events. There would also be another page that again redirects the page to the index page. The home page was completely made with HTML and for styling, the CSS was used and linked together. The index page has the main content, where we have linked the redirection to 4 categories, via buttons. This page also has QnA and FAQs buttons, which lead to google forms and a page respectively. The QnA has a google form which collects the queries of the

readers and stores it for further help. The most asked queries would hence be displayed in the FAQs section along with the answers. This also has a back button, which will always take you to the home page. The index page has a direct link to the official pdf released by the government about the new education policy. Then we have the 4 categories, if we select the foundation stage, we have two buttons, one for the infographics, on clicking this button, we get the creative image of the foundation stage, which can also be downloaded and shared amongst others.

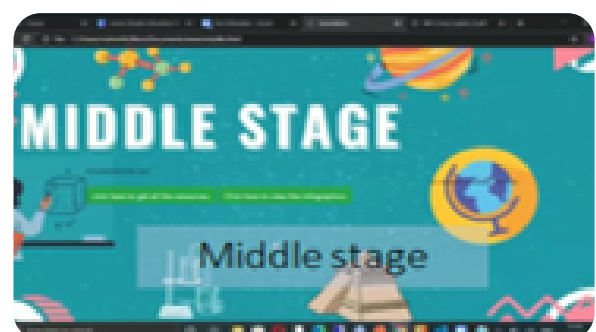
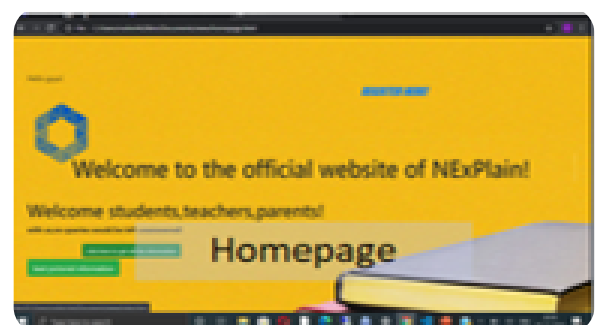

**Fig. 2 – Final Outcome**

The foundation page even has the button for resources, on clicking this button, we get all the links of the resource materials required for the foundation stage classes. On clicking the required link, one can download the pdf of the whole book. The foundation stage page also has a button that redirects to the home page. You can select any of the pages from the middle, secondary and pre-primary stages to get the information regarding the particular grades. Every page of the website has a creative background added too!

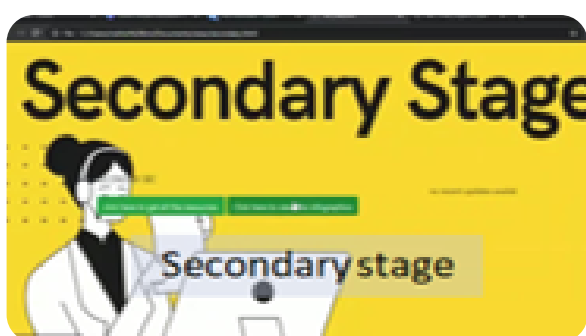
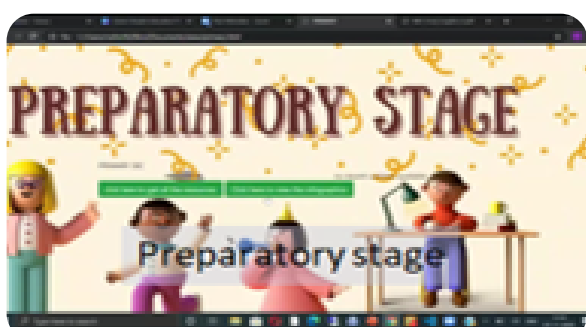

**Fig. 3 – Final Outcome**

The main task was to make a site that is easy to navigate and understand by the audience. The use of various animation codes was done to draw attention to certain links. It was not enough to just provide the information which already exists. So we also kept doubt solving section, and hosted zoom meets, provided new updates and

a wide range of materials for every standard. The website is convenient to all kinds of users be it students, teachers, or parents. The website caters to the participants of an ongoing cycle of education that is the students their parents and the educators. Delivering the most reliable and up-to-date content can help ease the chaos in this large audience caused due the changes.

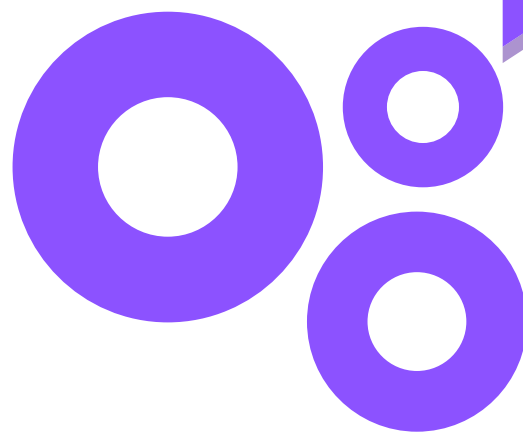

# Smart Water Management System

-A Solution to Control the wastage of water in your Household

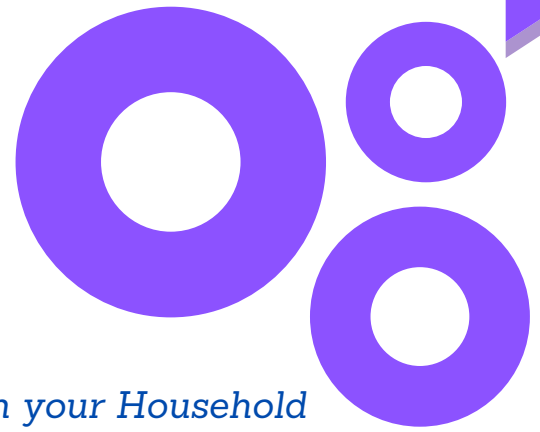

**MOHIT JAIN**

BE E&TC A



**SONU GUPTA**

BE E&TC A

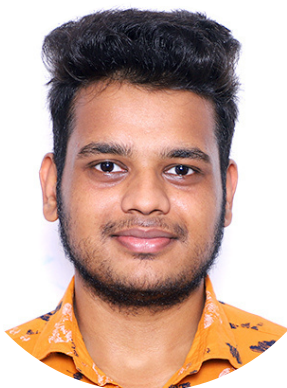

**HARSHIT SRIVASTAV**

BE E&TC A

*"It's Do or Die!!.." | On installation of a Water Management System in households.*

As we know that water is an essential resource for all life on the planet. Lots of people don't realize the true importance of drinking enough water every day. More water is wasted in many uncontrolled ways. This problem is quietly related to poor water allocation, inefficient use, and lack of adequate and integrated water management. Therefore, efficient use and water monitoring are potential constraints for homes and offices. It is a fact that by the year 2025 2/3rd of the world population will face water shortages, therefore there is an urgent requirement for a smart water management system that can be implemented in every household, dam, and every other possible water resource in order to save the future life on earth. Leaky pipes in our household, laundry loads, and overwatering the lawns are some examples of water wastage. It is observed that a leak in a pipe can cause a loss of 10,000 gallons of water per year.

Hence a smart water management system will be needed to be implemented so that people will be aware of water conservation. Live track of data will be provided in android devices. Considering the past systems there is a need for implementation of live data track which is required to be given to the user using an android phone so that the user knows at

what instance the water is getting used. The project would be implemented using hardware and software. The hardware part will consist of a sensors sub-system. The sensors sub-system consists of various sensors like turbidity, pH, ultrasonic sensor, etc and various types of microcontrollers. pH sensor will be used to check the acidity/basicity of the water, turbidity sensor will be used to check the pollution level of water and ultrasonic sensor will be used to check the water level. Microcontrollers will be used to send the data to the application software so that users will be able to see the live data about their water. The reason for using the sensor subsystem is that it is very important to check pollution levels in the water as this is also a part of water management.

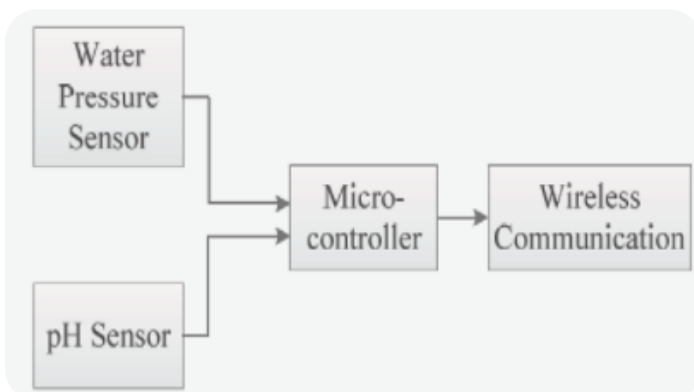

**Fig 1: Block Diagram of Water Management System**

In the future scarcity of water is going to become a major problem to mankind therefore there is an urgent requirement of a system for the management of freshwater. Further providing live track of data and warning the user through the android application whenever there is a wastage of water will be a good solution to the problem. In future, we look for better

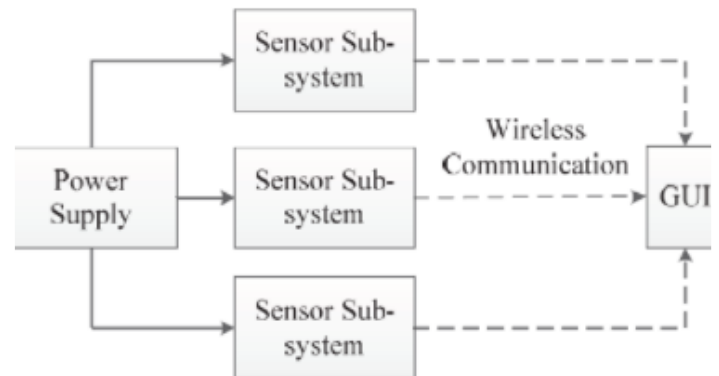
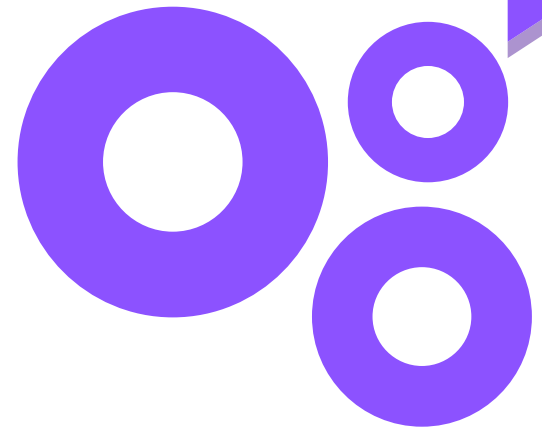

**Fig 2: Sensor Sub-system**

improved methodologies, more automation and more user-friendly application on this system and we hope that this system will be applied to dams, farms and every other possible water resources so that future generations will survive and live happily.

# Solagro



**RUSHIL PATHARE**

TE E&TC A

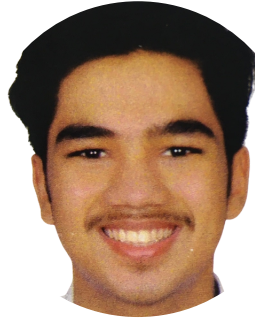

**VANSHAJ GUPTA**

TE E&TC A



**SREYAS NAIR**

TE E&TC A

In today's climatic conditions such as unprecedented amounts of rain and frequent heat waves, cultivating has become a tedious task. Predicting nature's next move is not easy but what we can do is minimize its effect on the yield. There are so many regions that receive excessive rainfall, suffer frequent flash floods and scorching heat. To adapt to these conditions, sensor networks can be deployed in the fields and the available resources should be used as efficiently as possible. In order to fulfill this requirement, power storage is capable of storing energy efficiently from solar panels and an irrigation controller which monitors the land, be it for farms, gardening, or horticulture with little to no intervention in certain aspects. The existing products in the market have proprietary parts, features and they don't endorse cross-compatibility with other products. Keeping the design open-source and easy to work promotes recycling and repairability something

essential in the current time of global silicon shortage. The current situation of agriculture in India is the same as it was years ago. Traditional methods are still being used in the agro-industry which in today's world are starting to become inadequate. The reason is the present weather conditions. Even though the technology implemented in the agriculture industry is evolving, the cost of these technologies is also rising. So due to this inflation in prices, a daily farmer or gardening enthusiast cannot afford the advanced equipment causing them to follow the traditional methods only. Or even if they can, they are limited and mostly rebadged generic products. Therefore, the project we are building is with the help of inexpensive parts and components making it an affordable affair. Not only its affordability is an advantage, but its ease of use, smart operation, and usage of solar panels guarantees simplicity, retrofit capability and use of clean energy.

## IMPLEMENTATION

The project is split into two parts, a power storage unit that harnesses solar energy and the other is the irrigation controller, which carries out irrigation activities on the farm.

Solar panels will be used to charge the lithium batteries stored in the power storage unit. The charging regulation, delivery, power telemetry data will be obtained from this module. The batteries are a few stacks of recycled lithium-ion cells which are designed in such configuration that they will make up a power storage house which then will act as a backup in case there isn't enough power provided by the panels or the grid itself for the operation. The unit is designed such that it is weatherproof and can be easily wall-mounted. It also has tamper protection, meaning if anyone fiddles with it or tries to open the unit, a notification will be sent to the app, and output power will be cut off for safety. Apart from this, it also presents with the daily power usage, energy left until the next sunrise, etc.

A controller (consisting of a microcontroller - ESP32) (fig.4) is going to be in a position that will control and monitor the irrigation. It will be connected to the power storage unit to meet its power requirements. connected to the power storage unit to meet its power requirements. Sensors such as moisture, liquid flow, and temperature

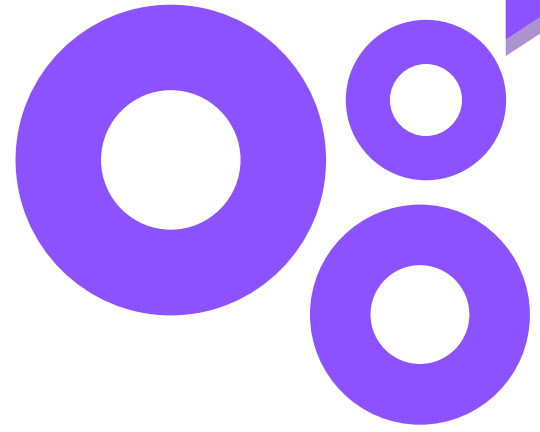

sensors are being used. These sensors will provide information directly to the irrigation controller depending on which the controller will decide how much water is to be irrigated by commanding the relays to switch the valves on or off and the pumps placed in the fields



**Fig 1: Power Unit**

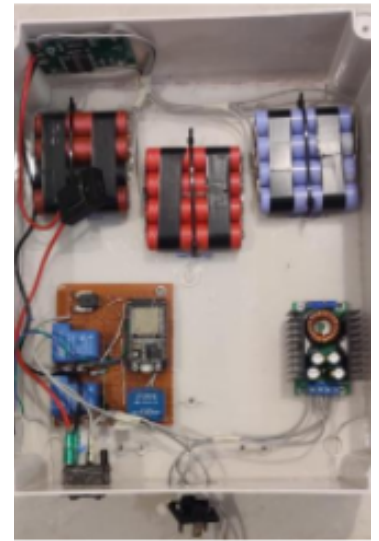

**Fig 2: Power Unit Internals**

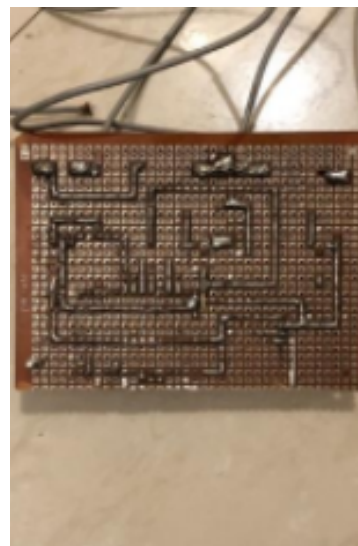

**Fig 3 : Power Unit Logic Board**

## RESULT

With this project, we are able to achieve fully automated irrigation. In the current technology, we are only able to see only timer-enabled irrigation systems but this project adds an innovative touch to this by adding such smart integrations for unpredictable rainfalls. The energy obtained is from a clean source and acts as a fail-safe in case of power loss from the grid. Introducing new technology such as lithium cells and PWM control of irrigation motors. The zone-based approach is fulfilled by the modular architecture of the system thus making future upgrades ease.

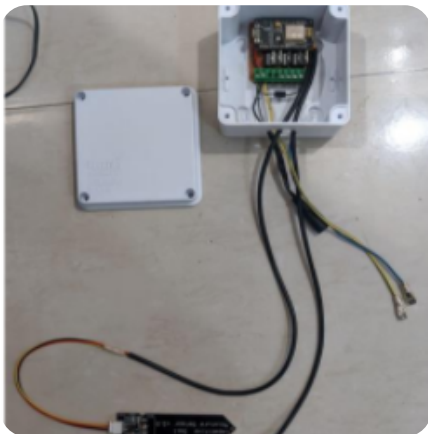

**Fig 4 : IRRIGATION CONTROLLER WITH SENSORS**

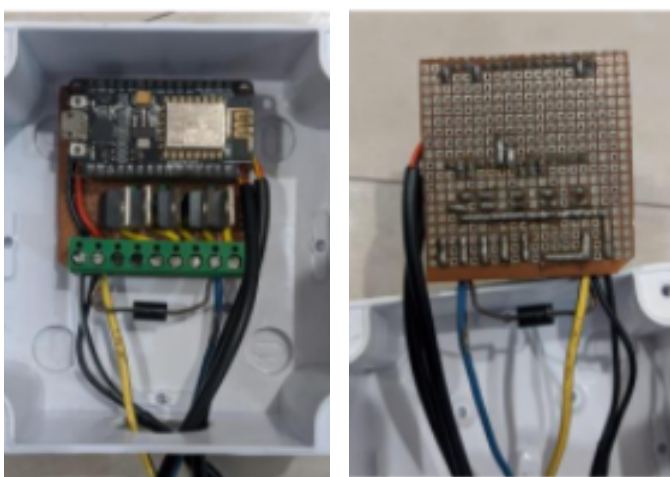

**Fig 5 : IRRIGATION CONTROLLER INTERNALS**

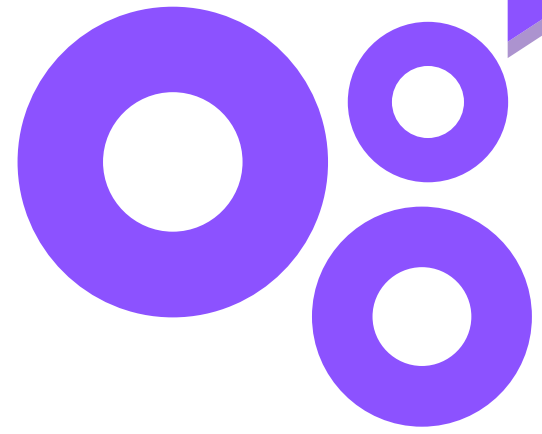

Thus, reducing the burden amongst other farm activities. The project uses all generic pins and connections making user upgrades and expansion of battery capacity an easy task, something that's not seen if off-the-shelf hardware, they all use manufacturer-specific standards to discourage third-party repairs and modifications. The user interface will display many parameters like solar panel power output, solar energy generated, weather, battery on/off state, zone-based irrigation where one can toggle the sprinkler on and off. The end-user will also receive daily notifications of how much power was consumed on that specific day.

The model is eco-friendly not only due to the use of solar panels but also because we are using recycled lithium-ion batteries. This system can prevent over-irrigation which occurs a lot in the agriculture world due to unpredictable weather conditions and lack of information. This is achieved by the information collected from the soil sensor and weather data. If the user acquires more land and wants to expand the solar panel area, it can be upgraded seamlessly.



# Bon Happétee: Measure calories from your food image

Nowadays, with easy access to the internet, food is delivered at our doorsteps just at the click of a button due to which people have started to consume a higher amount of fast food. This has accelerated the chances of suffering from a chronic disease known as obesity. Since obesity has become such a widespread disease, various mobile e-health applications have been developed for assistive calorie measurement to help people fight against health-related problems, hence increasing the demand for diet tracker applications.

Valerie Bertinelli remarked that “After a lifetime of losing and gaining weight, I get it. No matter how you slice it, the weight comes down to a simple formula of calories in, calories out”. Calories as well as other nutrition ingredients like fat, carbohydrate, and protein are measures of energy. There are more and more people who would like to keep track of what they eat and the number of nutrition content they get every day to see whether they are having a healthy diet. Therefore, an accurate estimation of dietary caloric intake will be very important for well-being.

The growing need for diet tracking in the world has evolved many applications that show you the calorie intake a food product can provide, our application does it in a different manner, we will provide the option of taking the input as an image. The application will take the image of the food product as the input from the user and process it to show the

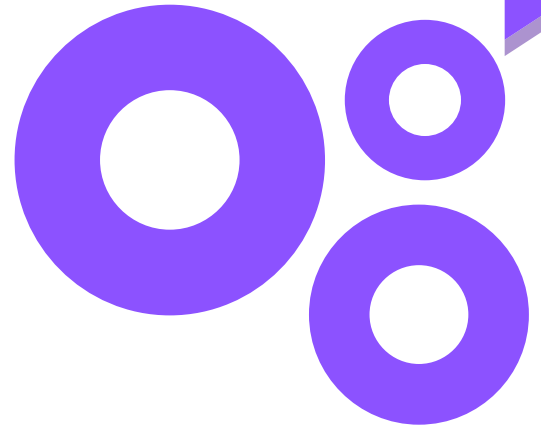

**ATUL TIWARI**

BE E&TC B



**PUNIT SAVLESHA**

BE E&TC B

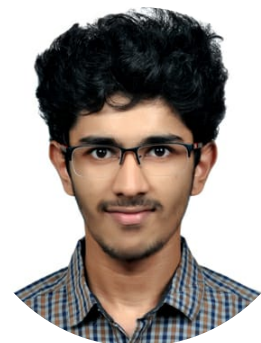

**YASH SHETIYA**

BE E&TC B

## LIMITATIONS OF EXISTING FITNESS APPLICATIONS

The existing apps have managed to detect the food item and calories of naturally available food items such as fruits and vegetables, but these models fail in the case of processed food. The concept of food detection is purely dependent upon features such as shape and color that are extracted from food images, in case of a change in the recipe the model may not give accurate results. There are numerous fitness applications that are available in the market but none of them offer a mechanism of calorie tracking through food image.

## FEATURES OF THE APPLICATION

- Log all your meals – breakfast, morning snack, lunch, evening snack, and dinner – to know whether you are within your calorie budget. Analyze the food you ate by getting a detailed macro-and micronutrient breakdown of it.
- Enter common restaurant dishes and packaged foods and track multiple serving sizes in the Indian context (such as *kachori* and *chapati* servings).
- Do not feel like typing? Track using images! The Photo Tracking feature lets you log meals by just taking a picture of the item or uploading an existing one.
- The Analysis tool displays the breakdown of the food items consumed into four dominant food groups – Protein, Fats, Carbs, and Fiber. Helping you understand what nutrients your meals are rich in, and what it lacks.

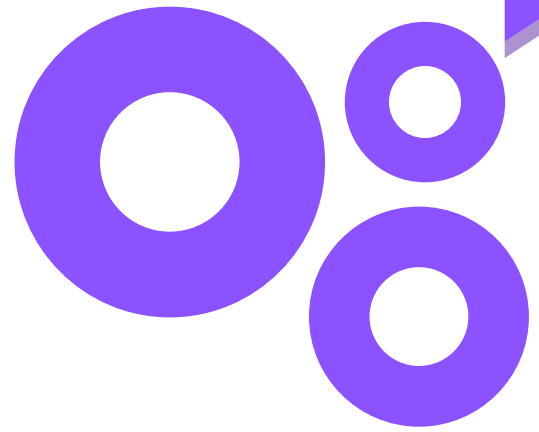

- There will also be a feature like Body Mass Index (BMI) calculator which will help users in their fitness journey.

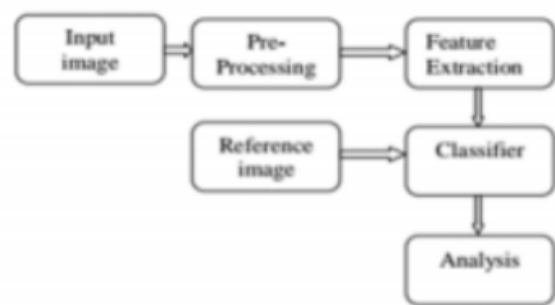

Fig: A block diagram for implementation of the application

## HOW WILL BE CALORIES COUNTED?

Image processing is a method to perform some operations on an image, to get an enhanced image, or to extract some useful information from it. It is a type of signal processing in which input is an image and output may be an image or characteristics/features associated with that image. Nowadays, image processing is among rapidly growing technologies. It forms a core research area within engineering and computer science disciplines too.

Food classification is particularly difficult because foods can dramatically vary in appearances such as shape, texture, color, and other visual properties. An essential

step in solving the food classification problem is to adequately represent the visual information of foods. This is commonly known as feature extraction. In our implementation, we extract color and texture features for food classification.

The image processing mechanism will begin by first taking the input from the user, the input here will be in the form of an image of a food product on which the user requires data. Every product will be having different characteristics; thus, preprocessing will be playing an important part, in which the volume calculation must be done i.e., the system will determine if there is more than one quantity of the same product, estimated quantity in case of cooked food.

To detect a particular food product from the input, segmentation should be performed so that features like the shape, color, and texture can be extracted by the system. Classification of the product will be done by implementation of algorithms like Convolutional Neural Network, Support Vector Machine, or KNN; it will identify the food product as per the trained image. Analysis and output would be the last stage in this process, it will fetch the calories and nutrition content of the food product which gets identified by the classifier. The application is mainly divided into two parts viz. (i) Calorie detection by image processing and (ii) Full-Stack web application using web technologies to develop a fitness and health product.

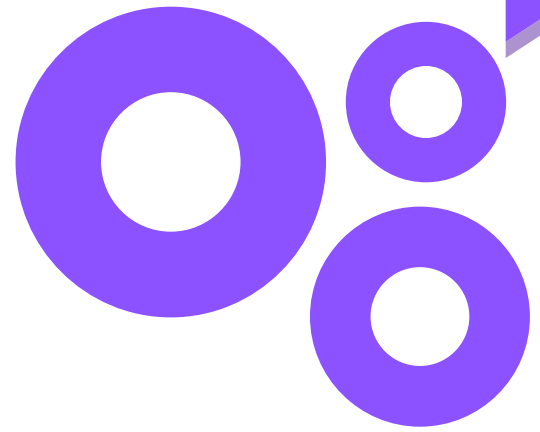

## **SO, WHAT DIFFERENTIATES OUR APPLICATION FROM THE OTHER APPS?**

The application will integrate the image processing technique of calories detection. This will help in the efficient and accurate detection of calories. The system will estimate the quantity of food and the calories will be calculated according to food name and quantity. The app will be developed on TensorFlow API and OpenCV for weight estimation and calories detection. All existing systems have used simple ML algorithms only. The use of Deep learning frameworks and libraries will increase the accuracy of the model. The application will be providing a UI platform for health and fitness tracking along with an image processing feature to automate the process of calories detection.

For many, calorie counting is a loaded term. Depending on whom you speak to it can invoke worrying emotions and all kinds of pressure. Thus, there is a huge requirement for such image processing applications that can minimize the time consumption in calorie tracking and make the process efficient.



**INDUSTRY**

# The Impact of Sudden Shift from Offline to Online during COVID-19

**MR. KISHOR CHAVAN**

Mahindra & Mahindra Ltd

Due to social distancing regulations and nationwide lockdowns, the Covid19 pandemic has inevitably increased the use of digital technologies. People and organizations around the world have to adapt to new jobs and lifestyles. Increasing digitization has led companies and educational institutions to switch to work from home (WFH). With the spread of the pandemic, almost all areas have been closed, closing activities that require meetings and interpersonal interactions, including universities, schools, shopping centers, temples, offices, airports, and train stations. The lockdown has caused most people to switch to the Internet and Internet-based services to communicate, interact and continue their work duties at home. This swift switch has impacted several domains in numerous ways.

## **INCREASING DIGITALIZATION**

The usage of video conferencing services such as Zoom has increased tenfold. Compared with the level before the lockdown, the utilization rate of Internet services has increased from 40% to 100%. As the use of video and audio conferencing tools increases significantly, organizations will strengthen their technical infrastructure to cope with the increase. This will lead to further investment in bandwidth expansion, network equipment, and software using

cloud services. As employees gradually adapt to the concepts of work from home (WFH), online meetings, and transactions, companies will turn to the WFH as the norm rather than the exception. Many companies are taking this approach and these companies have the right digital infrastructure to handle the necessary load and bandwidth.

## **IMPACT ON EDUCATION**

Education is another domain that has had a dramatic shift to an online transaction model. When many trades and production ceased, heroic teachers around the world decided to move entire classrooms into their homes and redouble their efforts to train for online courses, something most of them had never done before. This allowed the schools, colleges and universities around the world to transfer the courses through video conferencing platforms such as Zoom and Google Meet. India leads the world with 250 million students

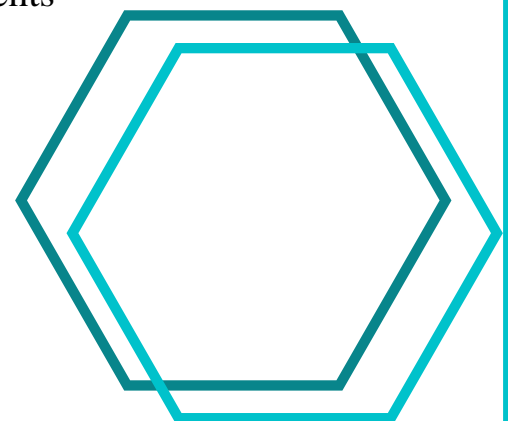

and has one of the largest networks of higher education institutions. India's education system shows a high degree of diversity, with more than 1.5 million schools and 50,000 higher education institutions, driven by more than 320 million young and enthusiastic students. The majority of these students are from the primary and secondary education sector, comprising up to 45% and 41% of the total respectively.

Total Students affected by Covid-19 in India (million)

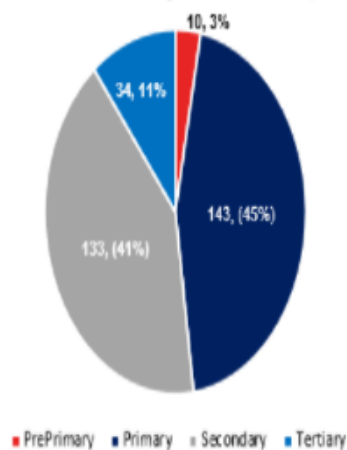

UNESCO

Educational activities are greatly hindered, and there is a lot of confusion due to the postponement or delay in examinations and academic conferences. The so-called supplementary courses do not have enough space. Training will be a huge challenge that needs to be given to teachers so that they have a correct understanding of digital education, not only can provide students with a real and appropriate education, but also can flow uninterrupted and smoothly. Considering the country's second-and third-tier cities, the huge reliability of power supply and consistent Internet connections may still be a long way from becoming a

reality. Compared with traditional teaching methods, digital education in India will lack personal experience. In addition, due to the lack of the learning environment obtained in traditional physical education institutions, the dropout rate of e-learning may be high. The impact of COVID19 on education in India is huge, but it pushes people to switch to technology. Not only can it provide a strong and powerful alternative to the traditional educational system, but it also reduces and compensates for the threat posed by the deadly virus to the education system

## WORK-FROM-HOME AND GIG WORKERS

During the COVID19 pandemic, many workers were advised to work from home as much as possible, redefining the traditional WFH concept, which is only applicable to certain types of jobs, occasionally or taking into account the unique situation of employees. The company is now determining whether it can significantly reduce operating costs by reducing the amount of office space required. In addition to companies that see the benefits of WFH, there are also direct benefits to employees. Most importantly,

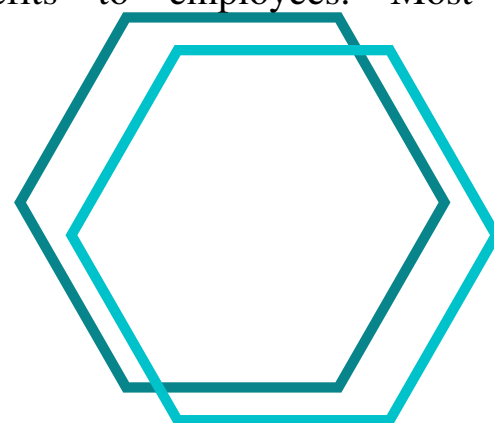

WFH saves commuting time and provides workers with greater flexibility in caring for their families. Although the WFH has benefits, it also describes many negative aspects of the full-time WFH. Employees who are at home do not have the opportunity to socialize with colleagues and can reduce physical activity, such as not being able to walk between meeting places. Additionally, prolonged screen contact due to full-time computer work can cause fatigue, fatigue, headaches, and eye-related symptoms. For people who live alone, working at a home full time without daily face-to-face interaction and social support can lead to psychological problems such as social isolation and depression. For others, fuzzy boundaries between work and life can make it difficult to mentally accept leaving work, which can increase stress and anxiety. A common problem at the boundaries of working life is balancing the work schedules of other family members. For some parents, work hours become “porous” because they may have to do household chores and run errands between work meetings. In some cases, parents may choose to sacrifice their sleep time and work at night or early in the morning because it is the only quiet time when they can focus on work and avoid frequent interruptions. The gig economy is powered by online platforms that hire workers on temporary, short-term, and mostly informal contracts. Well-known examples include Uber and Airbnb around the world and Ola and Swiggy in India. Since the great popularity of smartphones in

2010, these platforms have developed enormously. During the lockdown, the workers employed by these platforms have been greatly affected because the demand for their services, taxis, rentals, or skilled work has disappeared. Also, because these workers have no wage guarantee, their income has been drastically reduced. There are many more factors like online fraud, Internet access and digital divide, Internet governance, Surveillance and privacy, etc that are to be taken into consideration while discussing the impact of the shift to the digital platforms.

At the end we are all affected by the current COVID19 pandemic. However, according to our identities as individuals and members of society, our perception of the impact of the pandemic and its consequences is different. Although some people try to adjust to working online and let their children attend online classes, others have no choice but to keep society running while being exposed to the virus. Our different social identities and the social groups to which we belong determine our tolerance in society, which in turn determines our vulnerability to pandemics.

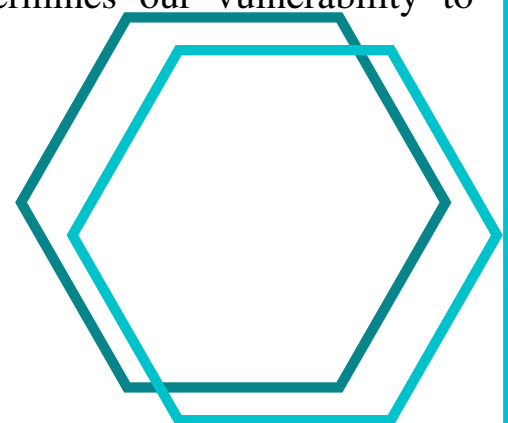

# Impact of COVID-19 on Small Businesses

**MR RAVINDRA KINI**

IDBI Bank

The COVID-19 episode has changed how we all view the world. All aspects of individuals' lives in India have been influenced, just as the economy, legislative issues, culture, and society. The coronavirus disease has caused a major economic shock in addition to its impact on public health. Indian start-ups contributed around \$11 billion to India's economy by the end of 2019, showing tremendous job-creating capacity [1]. The pandemic has caused large-scale chaos in small businesses only a few weeks after its establishment and before the government passed the Coronavirus Relief, Relief to provide assistance. 43% of businesses are temporarily closed, and almost all of these closures are due to COVID19. Respondents who temporarily closed mainly pointed out that reduced demand and employee health issues were the reasons for the closure, and supply chain disruption was a secondary factor.

## INDIVIDUAL SECTOR RESPONSES TO COVID-19 PANDEMIC

### • Port Sector

During the COVID19 pandemic, ports had to adapt to the reality of reduced freight volumes, shortage of workers, occupational health and safety measures for stevedores and ground crews, and the use of telecommuting and remote operations for office workers. In some countries/regions, the cruise call has been interrupted.

### • Meat Processing Sector

The COVID19 pandemic continues to put pressure on the agri-food industry from companies and workers, and some industries bear particularly high burdens. The meat industry is one of them. As the pandemic's impact on our food system continues to show, the lessons learned from the outbreak of processing plants in several major meat-producing countries are driving reforms that should contribute to sustainable development.

### • Construction Sector

The COVID19 pandemic had a huge effect on the construction industry, which is sensitive to the economic cycle [3]. However, on the positive side, the construction industry has great potential to stimulate recovery due to its job creation potential. In turn, recovery measures can support the industry's transition to sustainability and digitization. Tripartite cooperation and social dialogue, as well as international labor standards, are the keys to promoting a people-centered

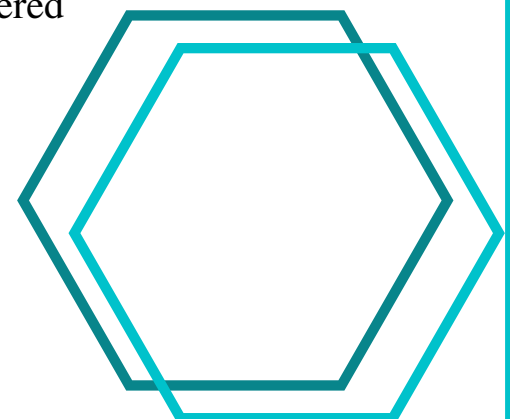



recovery from the crisis in the construction industry.

- **Passenger Transport Services**

The COVID19 pandemic has brought about unparalleled repercussions to urban passenger transport services. The impact on the different modes of urban transport is extensive, but one thing in common is that the volume of passengers for all modes of transport is decreasing. Urban traffic workers serve those customers: hospitals, nurses, and other key service personnel. However, they may be at the forefront of service delivery during a pandemic and may be at high risk of becoming ill.

- **Forest Sector**

The COVID19 pandemic has not only affected public health but also caused unprecedented damage to the economy and therefore, the labor market, including workers and corporations within the forestry sector. It compounds existing challenges and, as a result, many companies and workers suffer. In response, governments, employers, organizations and other forestry stakeholders all over the world are working together to mitigate the impact of the pandemic and protect businesses and livelihoods, including through social dialogue and promotion of international labor standards.

- **Public Sector**

Apart from the health and education workers, public servants also play a major role in halting the spread and recovering

from the pandemic. This is true no matter what their occupation is: whether within the administration of the state like tax collectors, police or correctional officers; or supporting compulsory social security systems like social workers; providing services to the community like waste collectors; implementing economic and social policies like labor inspectors. Public servants are indispensable conduits for recovery as custodians of public goods. The COVID-19 pandemic exemplifies the critical importance of disaster preparedness and which the private-sector partners cannot manage alone the scope of interventions needed now.

- **Food Retail**

Food retail workers have materialized as a brand-new category of frontline service workers during this pandemic. While essential to guaranteeing food security, they are themselves at high risk of exposure to infection and play a key role in food safety. To ensure enough numbers of food retail workers, they must be given access to training on personal protective equipment and hygiene protocols, as well as working conditions that provide

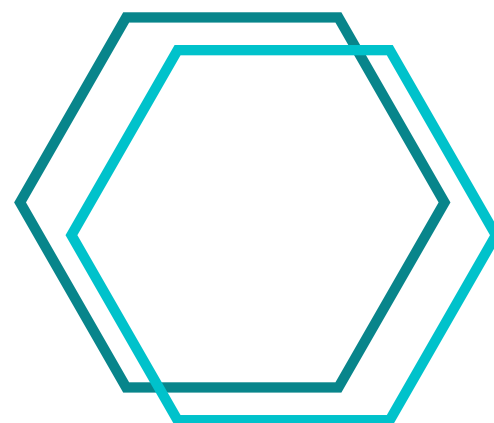

sufficient wages and access to social protection, including paid leave.

- **The textiles, clothing, leather, and footwear industries**

The feasibility of the textiles, clothing, leather, and footwear industries is unraveling, since workers are told to stay at home, factories close, and global supply chains grind to a halt. The exponential decrease in the number of orders has hit thousands of firms and many workers particularly hard. We urgently need unanimity and joint action across the industries' supply chains. The governments should work towards the protection of the health and economic well-being of workers and businesses within the textiles, clothing, leather, and footwear industries.

Social-distancing restrictions and health- and economic-driven demand shifts from COVID-19 were expected to shutter many small businesses and entrepreneurial ventures, but there was very little early evidence on impacts. The initial effects of COVID-19 on small businesses and entrepreneurs are not well known due to the lack of timely government data for businesses. With major losses in business activity in April 2020 and continued losses in May and June 2020, even though these losses were smaller, business owners had already lost substantial amounts of income from their businesses. It was also uncertain whether the shutdowns of the companies/short businesses were temporary or permanent because of the pandemic impact.

Governments have been responding to worries over the long-term effects on small businesses through several programs. Could these programs be helpful to small businesses in surviving the drawbacks and shutdowns caused by the coronavirus pandemic, or will more assistance be required?

**COVID-19 is especially threatening for several sectors.**

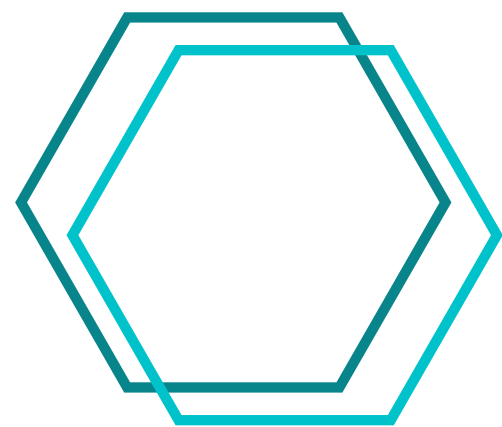
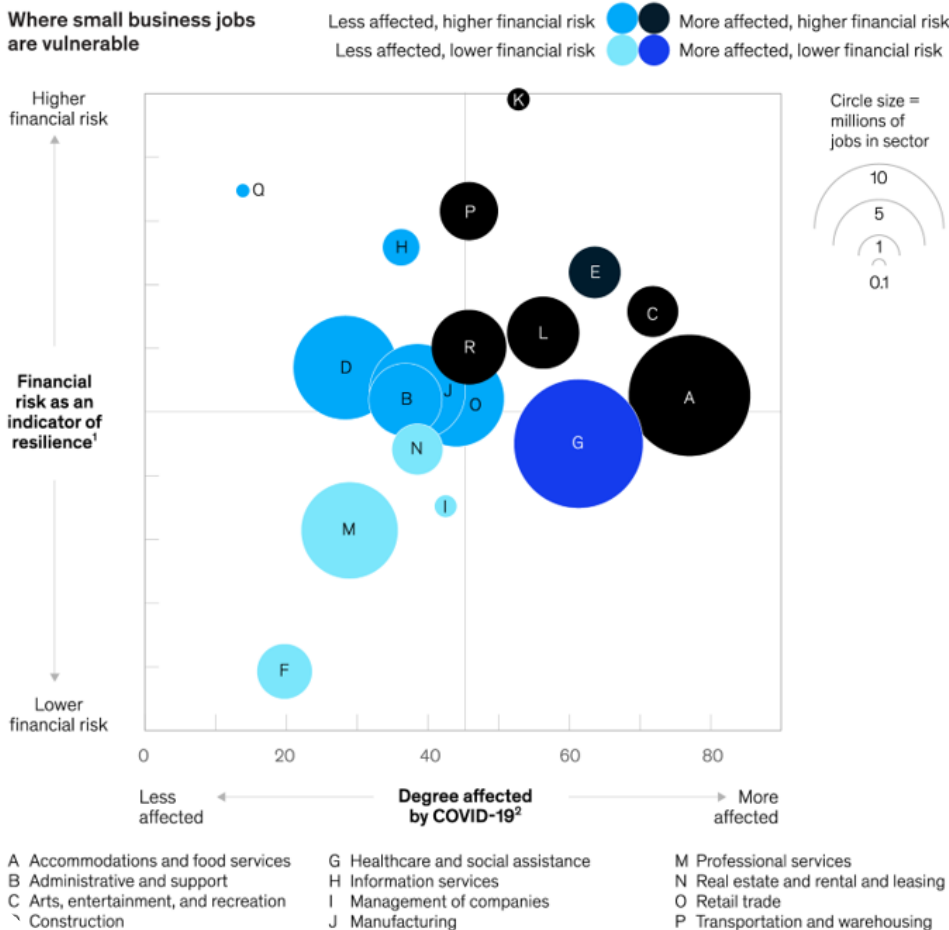



**ALUMNI**

# Painting outside the Boundaries

**NISHANT DEHERKAR**

2017 Graduate, E&TC - A

Dear student,

Do you remember the first time you picked up crayons and painted or colored and just had pure fun? You most likely also colored outside the borders. That is who we are on the inside, like kids, explorers of “What if I go beyond the boundaries and limits?” I stepped into my degree in Electronics & Telecommunication (E&TC) in 2013, graduated and joined Infosys in 2017, completed 4 years in the IT sector, and now work with Ernst & Young. I have my own handcrafted self-coded website, do animation and digital graphic content for nonprofits, have self-published a collection of poems on Amazon, was placed as the second-best public speaker in Kerala & Karnataka in 2019 in an international fraternity of Toastmasters, and have always tried coloring outside my boundaries but with all these experiences, what has become my north star is value creation by creating better life experiences for people of various walks of life. Following are three boundaries in my life that I colored out of to take a step towards creating my own identity:

## **Boundary 1: Privilege**

If you are studying in a top-tier college in an urban city, you are very likely to have been privileged with resources and chances that most of the population in our country does not get. As a kid, I would feel bad and would not understand why poverty exists in a world where you also have a decent number of millionaires. During my time at TCET, I took the decision to join the NSS (National Service Scheme) Chapter of the college. Every weekend was a new window into the lives of those with lesser resources and even more, challenges to deal with, be it the slums in the Thakur area or a village near Vasai. The NSS experience gave me the exposure to starting building a foundation of understanding societal issues and what can be my bit to help make lives better. This is not to become great or get the glory of altruistic pursuits but instead to say that you realize that if by the end of life all that you will carry are experiences, then you might as well help create better experiences for those who face the dark side of a society that is not equitable and still strives for equality across dimensions. For the past year, since the onset of Covid, I carried ahead my foundational understanding of societal issues and tech skills to help certain non-profits in their journey to



make the lives of people in marginalized communities better. While money is great in its own right, there is something about changing a person's life narrative that gives a prolonged sense of peace. Coloring outside your boundary of privilege will be tough, accepting that you indeed did have a good start with opportunities and not having to deal with certain life problems, and as overwhelming as it may be, doing so will open a whole new world to you.

## Boundary 2: Communication, Storytelling

If you ever hear the idea that "Communication is one of most essential skills one can learn", especially in your business communication classes, then please do believe it. As people progress through their careers, they get great at tech skills since that is your literal bread and butter, but soon they start hitting dead blocks of personal and career growth since they did not take conscious effort to work on their communication and storytelling. Being able to tell a narrative to influence, persuade, convince; is too powerful a skill not to have. Right from networking to giving a client presentation to raising funds - irrespective of the sector/industry you work in - communication and storytelling end up being crucial. There is a reason why brands

like Apple influence culture and why communication channels and technologies like Facebook undergo political scrutiny. Our culture is influenced by stories and changes in our narratives influence culture; what is cool today may be canceled tomorrow due to its negative impact on humanity. It all starts with you, right from the way you decide to spend your time. I get it, some of you want to be the coolest kids, some want to be the richest, some want to just feel normal, some want to be great, and some want to do great things (being great and doing great things and not the same, in case you're wondering), and some are figuring out what they want to do. It is your story. Take a step back and understand the stories you're already a part of. Ask yourself if you want to continue being part of those stories. If not, you hold the power to change your context and that influence culture. I hated talking to people, and I had social anxiety for most of my college days. I worked on my communication skills after college, invested time in learning storytelling, right from teaching 8000+ graduates at Infosys as an Educator (yes, my first role was that of an Educator) to delivering a 7-minute speech about identity to 600+ people at a conference in Bangalore resulting in being awarded as one of youngest best speakers in Karnataka and Kerala in the international fraternity of Toastmasters, to help create an animated video for a non-profit that worked with young women in rural India and then



starting my own initiative - the design cauldron (<http://thedesigncauldron.com>). If you can get yourself to color outside this boundary of comfort with communication and stories, you will definitely find tools that will boost your career and life in ways you cannot imagine right now but will connect back the dots in retrospect. (PS - TED talks, which are deemed great, tell the best of stories and not just facts and there is a reason why)

### **Boundary 3: Belief in yourself**

This one is close to my heart because for a long time I did not believe in myself. I looked for evidence and proof and reasons to do so. I'll say it directly - don't waste your time looking for proofs. You are already good enough. You don't need a reason to believe in yourself. Engineering is a roller coaster ride. You are stepping into becoming an adult, understanding bigger things in life, meeting new people, feeling anxious, crazy, overworked with exams, stressed about submissions, making sense of your emotions, searching for a passion for life, figuring out how to start your career, your masters, probably driving your a vehicle or learning how to do so, planning for sleepovers and hangouts and feeling bad about the ones you were not invited for, or

dealing with real-life problems back at home - yes, it's crazy and it becomes all the tougher to believe in yourself while dealing with all this. So I'll say it to you - I believe in You and your potential and ability to do great things. You will become great as a consequence. But believe. Simply because you can. Also, definitely be honest with yourself about your actions. A lot of people try to impress, and be cool; chuck all of it, it's too mainstream and after a point, everyone realizes you are trying too hard for something materialistic that doesn't matter much. Believe in yourself, be honest with what you do and why you do it, and create value. Everything else will consequently fall into place. People do great things and then attain greatness as a consequence. It took me a long time to believe in myself and I still struggle at times, but it's better now. I hope you make it easier for yourself with self-love and believing in yourself.

If you are in the EXTC department, you definitely will achieve the skills of endurance, rigor, work ethic, hard work, and time management. If you are able to invest your time and mind and heart into it, you will understand human-centered design and get the skills to start creating machines, gadgets, or do research that helps create better life experiences because the EXTC track allows you to implement and create tangible projects and equips you with the knowledge required for it,



right from your microprocessors to your antenna simulations to probability & image processing. If you are able to color outside the three boundaries mentioned above, you most likely shall find a path to paint a better painting of the world where you use your tech skills, your domain knowledge, and your abilities to help create better life experiences for people who need it more now than ever before, in parts of the world you do not know exists, facing problems you cannot imagine right now. Covid was a good test for this if you haven't realized it already. And if you're wondering why should one strive for a better humanity and do this kindness? Because you can.

With warmest of regards,  
Nishant Deherkar  
2017 Graduate, EXTC - A





**FACULTY**



# Optical Elements & its properties



**RASHMITA KUMARI MOHAPATRA**

Asst. Prof. (E&TC)

Many practical gadgets use laser light to achieve various functions such as fiber optic communication, laser printing, 3D printing, medical imaging, 3D imaging with LIDAR, etc. Even daily devices such as smartphones and gaming controllers use infrared light for facial detection and motion control. Such applications are made possible by the fact that these devices are able to project, manipulate and detect complex patterns of laser light, as required by the application. The key component that makes this possible is an optical element that manipulates the laser light called diffractive optical elements (DOE).

DOEs work is based on the principle of optical diffraction discovered many decades ago. DOEs consist of tailored microstructures that alter the phase of the incident light (typically lasers), allowing it to change the shape, profile, and amplitude of the laser. Advances in microfabrication techniques have allowed for the fabrication of DOEs with sub-wavelength microstructures that have enabled a sea of novel possibilities.

DOEs:

- Offer many novel optical characteristics which cannot be realized using traditional refractive or reflective optical elements
- Are smaller, thinner, and lightweight making them extremely compact and easy to integrate
- Are highly precise with negligible angular tolerances and robust long-lasting performance
- Can be made on many materials such as Fused Silica, Germanium, Zinc Selenide, Polymers, etc.

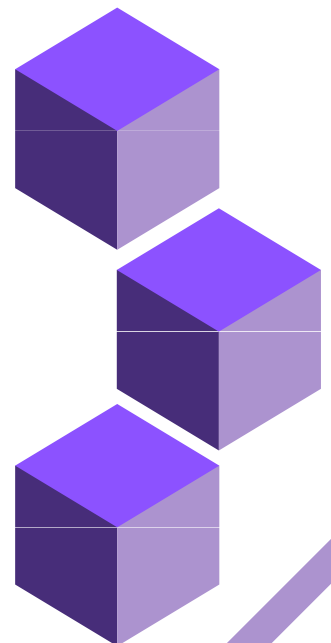

## Beam Shaping

DOEs that manipulate the incident laser light to produce a well-defined output beam with uniform intensity are called beam shaping elements. Such elements can be used to produce spots of typical shapes such as round, square, or any arbitrary shape as desired. Such elements are commonly used in spectroscopy, 3D imaging, and medical diagnostics. Beam shaping DOEs include both diffractive and broadband diffusers (suitable for shaping multimode laser beams) and analytical beam shapers, that provide unparalleled shaping accuracy for single-mode beams.

## Beam Splitters

Beam splitter elements are DOEs that split the incident laser light to produce several well-defined output beams (called “orders”) with controlled intensities. The output beams pattern can be arranged in shapes such as a square, line, round, hexagon, or any other arrangement as desired including pseudo-random patterns, with precise separation angles between the beams. Such elements are routinely used in laser scribing, laser micromachining, and medical aesthetic treatments.

Beam splitting DOEs can be tailored for:

- Accurate separation angles
- Any wavelength from UV to IR
- Any desired number of orders and intensity of orders

## Beam Foci

DOE that primarily manipulates the focal properties of the incident laser light is called beam foci elements. They can be tuned to alter the depth of focus, split the laser focus into several foci with controlled focal separations or focus several wavelengths into the same exact focus plane. Such elements are used in Laser glass cutting, light-sheet microscopy, cytometry, and other applications involving transparent materials.

Beam foci DOEs have the following families:

- Increased depth of focus – Elongated Focus DOE
- Splitting of an incident beam into multiple foci with uniform separation – Multi-focal DOE
- Focusing several wavelengths to the same plane – Diffractive achromat

With such useful properties, DOEs are poised to bring about immense benefits to optoelectronic laser systems in the coming years.

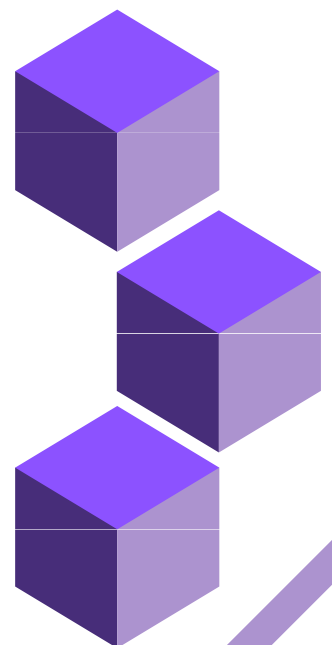

# Role of Engineers in today's modern world



**PURNIMA CHANDRASHEKAR**

Asst. Prof. (E&TC)

An engineer has a multifaceted role. They don't just need an understanding of science and mathematics or work with machines, designs, or circuit boards to become a good engineer. What is needed is an understanding of the role that he/she will play within a company, and ultimately within society. An engineer should be involved in negotiations, become a manager, lead in supervising the work of a team of engineers, be responsible & accountable to ensure the work undertaken is safe or to ensure it is not damaging the environment [1]. Using the knowledge that has been gained in the four years of an engineering degree to build something that's impacted people's lives for the better is what a socially responsible engineer should aim to do. In an advanced technological world, the need of the hour is for engineers to bring ideas into reality. By applying the principles of mathematics and science, engineers are capable of developing solutions to the world's biggest technical issues [2]. The creative work of engineers is often hidden in the details of everyday life, invisible precisely because it

works. Car braking systems, water treatment, gas turbines, and mobile data networking, are just a few examples of continuous, creative innovation and improvement by engineers that keep us safe, drive the economy and support our modern lifestyles. [1]. Innovative ideas are at the heart of what engineers do, and they are capable of using their knowledge to create new and exciting prospects and solve any problems that may arise [3].

With creativity comes the added baggage of responsibility. As much as engineers have built cars, devised roadways and motorways, the social and environmental problems of congestion, urban sprawl,

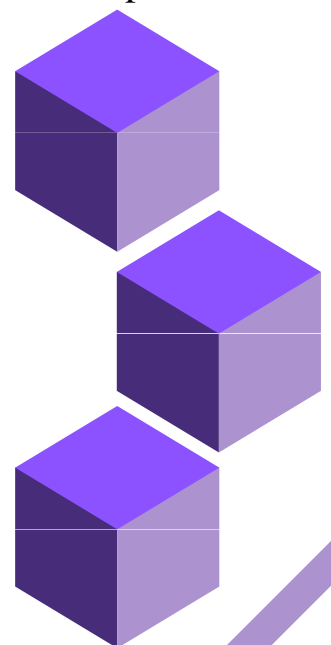

emissions and rising fuel costs, crumbling healthcare systems, etc. have made it imperative to address these problems through energy efficiency and renewable energy as also through innovative engineering solutions [1].

Engineers, in today's modern world, should be able to come up with solutions as and when need arises. Today, world over, people are fighting a tough battle against the invisible corona virus. Millions of enterprises face an existential threat. Nearly half of the world's 3.3 billion global workforce are at risk of losing their livelihoods. Informal economy workers are particularly vulnerable because the majority lacks social protection and access to quality health care and have lost access to productive assets. Developing long-term sustainable strategies to address the challenges facing the health and agri-food sectors is one of the key areas where an engineer can pitch in [4].

As it is rightly said, "Necessity is the mother of invention", today countries all over the world have understood the potential of invention and innovation. In an effort to beat an unseen foe, scientists, engineers, and inventors have increased time, investment, and thought for the benefit of all in the form of innovations that fight the pandemic on all sides medically, financially, and even politically [5].

In India itself, so many innovative solutions have been designed and developed.

- Many college students from our country have worked towards aiding the medical staff and developed oven-sized, low-cost, and portable ventilators that are expected to deliver 500-600 ml of air per breath and 15-18 breaths per minute, as specified for Covid-19 patients [6].
- A doctor in our own Indian navy has developed a high breathability PPE kit suitable for our Indian climate, which is humid and hot. This has helped Indian Navy acquire a patent in association with the National Research Development Corporation (NRDC), a body under the Ministry of Science and Technology in the same [6].
- Indians have developed a first of its kind tunnel which is covered with polythene sheets and uses an organic fumigant instead of Sodium Hypochlorite to sanitize people who

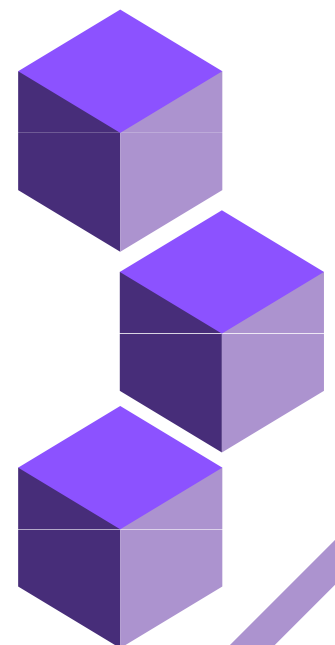

enter the same. This helps contain the spread of the virus in those places through clothes or bags or other products carried by a user [6].

- A few doctors of Maharashtra have developed a COVISAFE transport system which is completely safe to transport a patient from one place to another without infecting the people, including ward boys, nurses, and doctors, traveling with him/ her. The transport system has ventilators and oxygen inside it which can be used by the patient, however, the air that comes outside the box is safe air because it is filtered [6].
- Airport cleaning robots, germ trap masks, sanitizing UVD robots, etc. are just a few of the budding innovations across the world that have helped deal with this invisible virus in a much better way.

The future for budding engineers seems bright. Helping society navigate in the post-COVID 19 worlds will require innovation of technological ideas and a positive mindset to deal with uncertainty.

### References:

- [1] R. Lawlor, Engineering in Society, [Online]. Available: <https://www.raeng.org.uk/publications/reports/engineering-in-society>
- [2] “The importance of engineering in the modern world”, [Online]. Available: <https://www.studyinternational.com/news/importance-engineering-modern-world/>
- [3] “How exactly does Engineering impact society?”, [Online]. Available: <https://get-trained.org/latest-news/how-exactly-does-engineering-impact-society>
- [4] “Impact of COVID-19 on people’s livelihoods, their health and our food systems”, [Online]. Available: <https://www.who.int/news/item/13-10-2020-impact-of-covid-19-on-people-s-livelihoods-their-health-and-our-food-systems>
- [5] Joseph Hadzima, COVID-19: The Mother of Invention? [Online]. Available: <https://info.ipvisioninc.com/blog/covid-19-innovation>
- [6] “7 creative engineering solutions from India to deal with Covid-19”, [Online]. Available: <https://www.indiatoday.in/education-today/featurephilia/story/7-creative-engineering-solutions-from-india-to-deal-with-covid-19-1714550-2020-08-24>

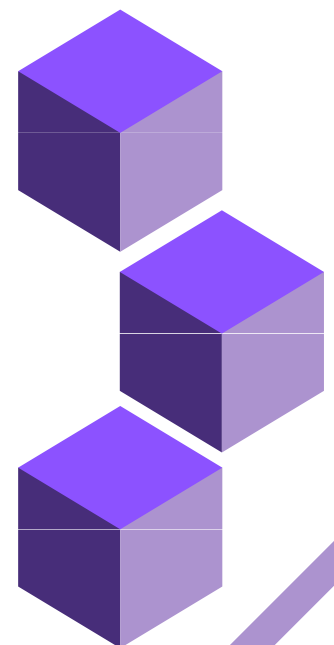

# TEAM



**NEHA  
JAISWAR**

Publication Head



**SONAL  
RAO**

Head of design



**SHIVSHANT  
SINGH**

Chief Curator & Editor

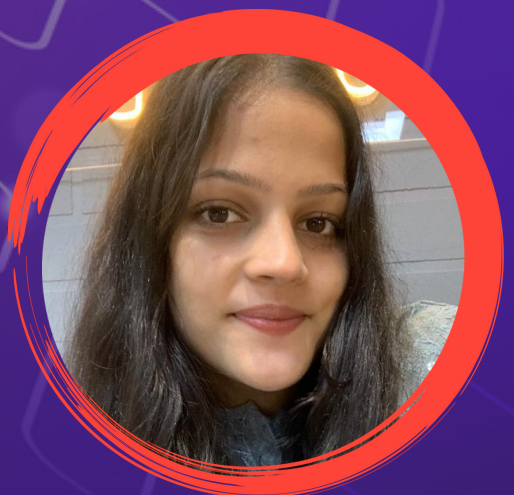

**AASHVI  
JAIN**

Researcher



# ANANYA SRIVATSAVA

Curator

# VIKAS LODH

Designer



# SHWETA CHAVAN

Curator



# ROSHINI KINI

Editorial and  
Research

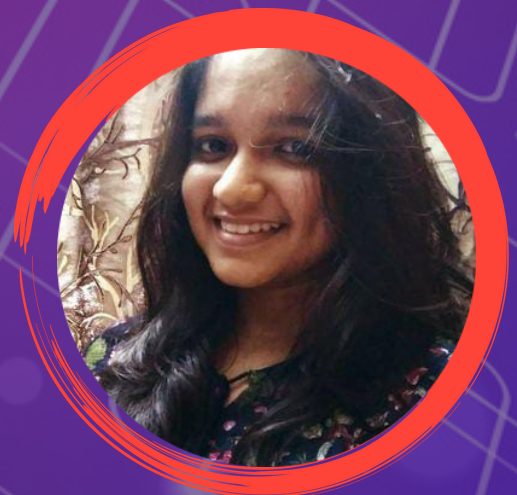

# HARNEET DEHIYA

Editor







## ACKNOWLEDGEMENTS



We take immense pleasure in presenting before you, Abhivarg 6.1. The magazine isn't just a drop in the ocean, it's another milestone for the years down the lane and years to come. We rest assure you that we have strived to maintain the dignity and the pride of the magazine.



We would like to place on record our gratitude to the Chair man, Trustees and CEOs of the Thakur Educational Group. We profusely thank our principal, Dr. B.K.Mishra, our vice principal, Dr. Deven Shah and Dean (SSW), Dr. Lochan Jolly for their constant support and encouragement.



We take this opportunity to express our gratitude towards everyone associated with the magazine's publication. We are grateful to all our esteemed professors, especially our Faculty In-charge, Ms. Megha Gupta for her support and guidance.



As the Abhivarg magazine passes yet another edition, a heart-warming thanks to all the people who bestowed us with their support, many authors who gave way to this magazine by yielding their magnificent research work and the roof of it all, our readers for their ceaseless support

-Team ABHIVARG 2021

